

# Operating Instructions.

- Aconda 9272
- Aconda 9372
- Aconda 9281 HD
- Aconda 9381 HD

TV.

**Neu für 3.Auflage:  
S11, 14, 16, 17, 18, 19, 24**



233-31308.020

**LOEWE.**

# Contents

<b>Remote control – TV functions</b>	<b>3</b>	<b>Daily handling</b>	<b>10</b>	<b>What to do if ...</b>	<b>21 – 22</b>
<b>Control panel</b>	<b>4</b>	Switching on/off	10	<b>Technical data</b>	<b>23</b>
<b>Rear connections</b>	<b>5</b>	Changing channels	10	Mechanical data	
<b>Welcome</b>	<b>6</b>	General menu operation	11	Electrical data	
Thank you		Adjusting the sound	11	<b>Accessories</b>	<b>24</b>
TV equipment		Adjusting the picture	11	<b>Service addresses</b>	<b>24</b>
Setup		Operation on the set	11		
Cleaning		<b>Modes of operation</b>	<b>12 – 17</b>		
<b>For your own safety</b>	<b>7 – 8</b>	TV mode	12		
<b>Initial installation</b>	<b>9</b>	Picture in picture	13		
Batteries – remote control		EPG mode	14 – 15		
Connection		Teletext mode	16		
Switching on		Video mode	17		
Initial installation		<b>Operating additional equipment</b>	<b>18 – 20</b>		
		Logging in and connecting			
		AV equipment	18		
		Video playback	19		
		Loewe video recorders and direct operation of Loewe DVD players	20		

# Remote control – TV functions

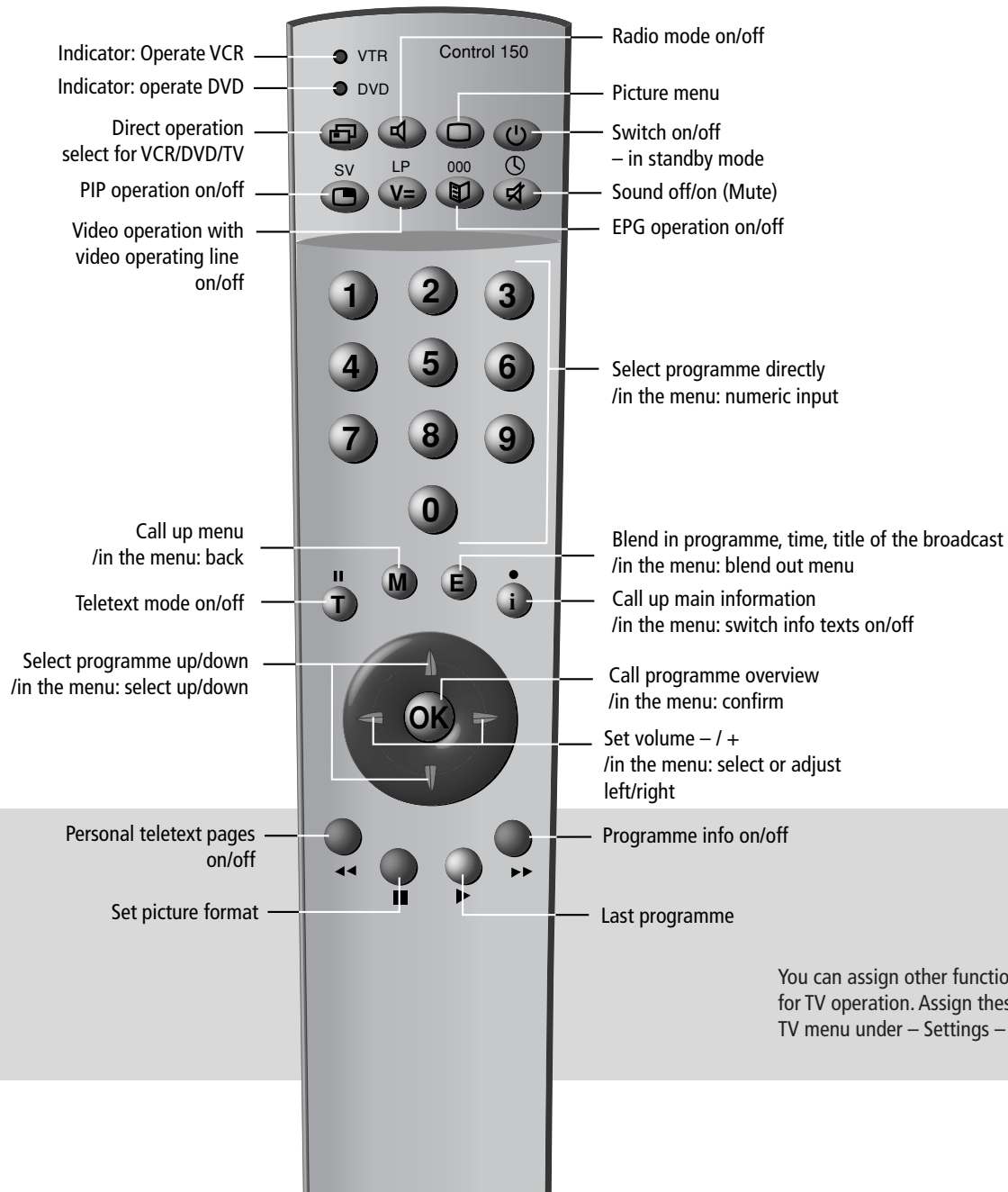

# Control panel

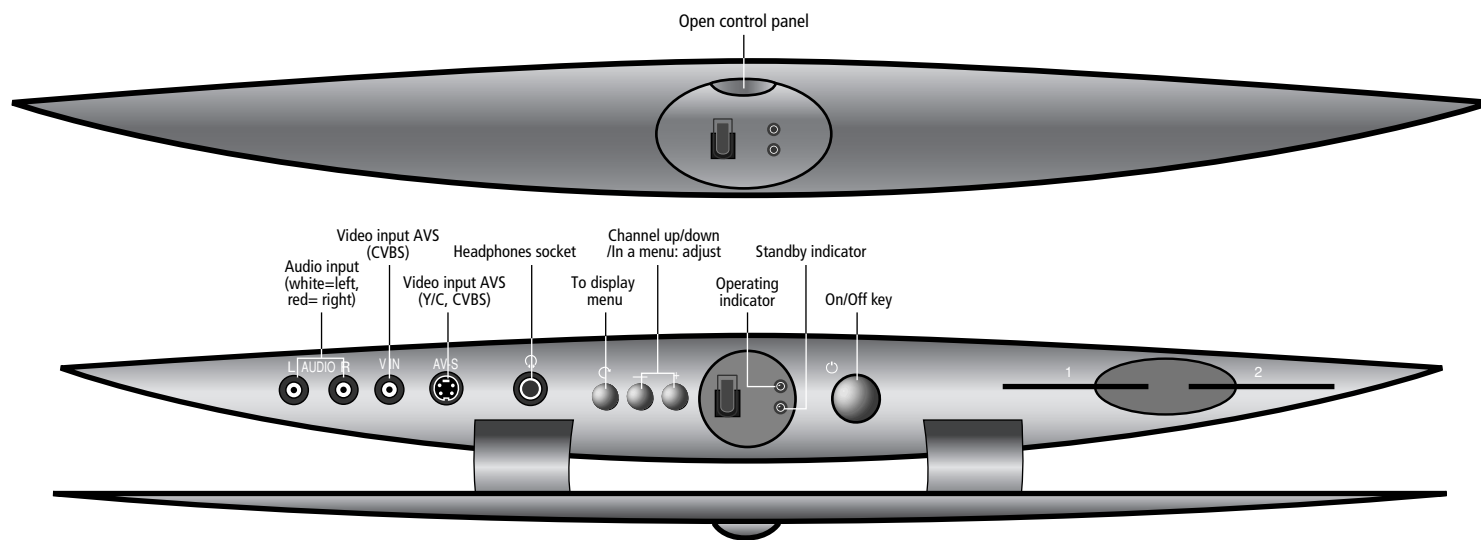

# Rear connections

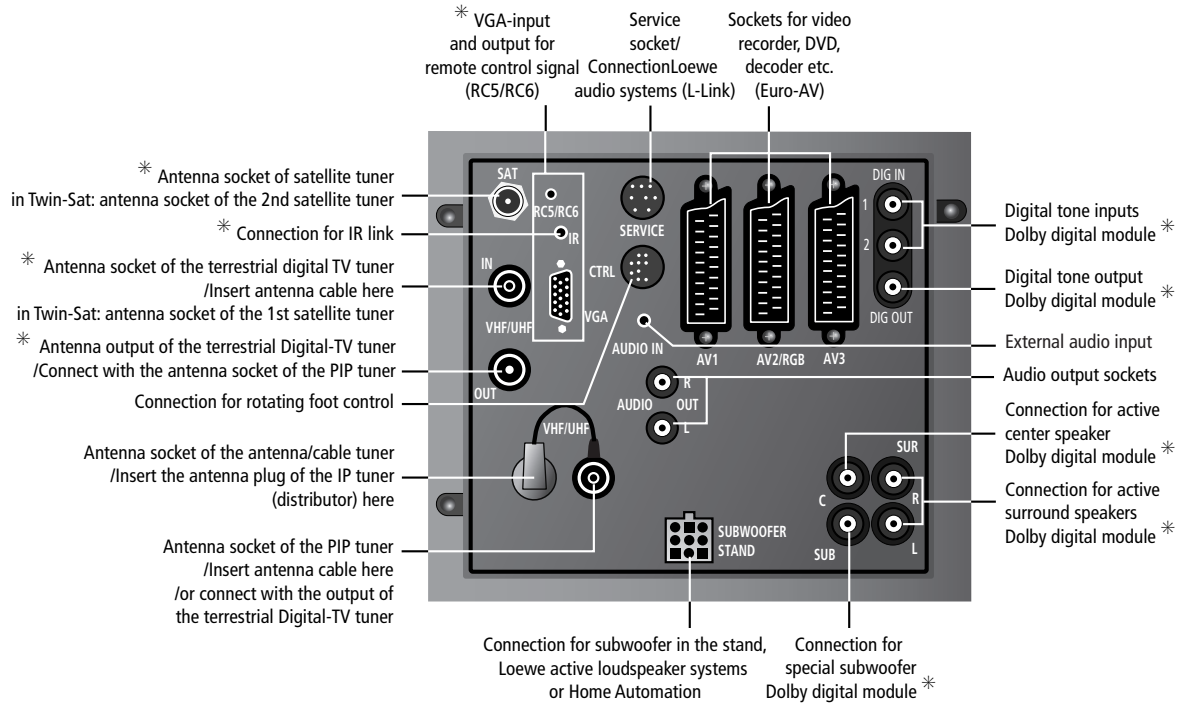

\* can be retrofitted

# Welcome

## Thank you,

for choosing a Loewe product.  
We are very happy to have you as a customer.

Loewe combines high quality in technology, design and user friendliness. This applies equally for TV, video and accessories.

Neither the technology nor the design are an end in themselves but serve to give our customers pure watching and listening enjoyment.

We have not allowed ourselves to be led astray by short-lived fashion trends in the design. You have, after all, purchased a high-quality piece of equipment which you don't want to get tired of looking at tomorrow or the day after .

### About the set

**We have designed the TV set in such a way that it is easy to operate with menus. If you need information about how to operate it, just display the info texts with the i button, you will soon get a grasp of the relationships.**

**You will find the answers to many technical questions in the index of your TV set. If it's a matter of operating the TV, you can access a function directly from the index. This saves you from having to read through detailed operating instructions and is the reason why this operating manual you are reading only explains the most important operating steps.**

With the remote control, you can operate three Loewe units, this TV, a Loewe video recorder and a Loewe DVD player.

## TV equipment

This operating manual describes the maximum equipment.  
Functions marked by <sup>s</sup> are not available in all TV sets.

The illustrated menu contents may vary depending on the TV equipment.

You can find out what equipment your TV has in the main information – Technical spec. of TV set.

## Setup and cleaning

Please note that the feet of the TV set could leave marks on soft wood furniture (e.g. deal, pine, fir etc.) due to the weight and moving the set about.

The plastic material of the feet contains softeners which could in some cases etch the surfaces of furniture.

In such cases you should place a firm underlay about the same size as the base of the TV set underneath it.

Please also read and observe the safety instructions on the following pages.

Make sure no bright light or sunlight falls on the screen and impairs the picture by reflections.

## Cleaning

Clean the TV set and the remote control only using with only a damp, soft, clean cloth (never use aggressive or abrasive cleaning agents).

# For your own safety

**For your own safety and in order to avoid unnecessarily damaging your TV set, please read and observe the following safety instructions:**

- This TV set is designed exclusively for receiving and reproducing audio and visual (AV) signals.
- It is designed for the home or office and may not be used in rooms with high humidity (e.g. bathroom, sauna) or a high concentration of dust (e.g. workshops). If the unit is used in the open air ensure that it is protected against moisture (rain, dripping or splashing water, or dew). Do not place containers filled with water, such as vases, on the TV set. High moisture and dust concentrations produce creep currents in the set which can lead to danger of electric shock or fire. The manufacturer's warranty is only valid for use of the TV set in the specified permissible environment.
- This set may only be connected to a power supply with the voltage and frequency specified on the rating plate using the enclosed power cable. The wrong voltages can damage the set.
- If the set is moved from a cold environment to a warm room, condensation forms on all parts of the set. Moisture produces creep currents in the set which can cause a fire. In this case, you should leave the set for a reasonable time to acclimatize (when the condensation on the screen has evaporated) before switching it on.

- Like every piece of electronic equipment, your TV needs air for cooling. Obstructing the air supply to the set can cause fires. The air vents on the back of the TV set must always be kept free. Do not leave newspapers or cloths lying on the TV set. The air supply is also impaired when the TV set is placed on a blanket or a thick pile carpet.

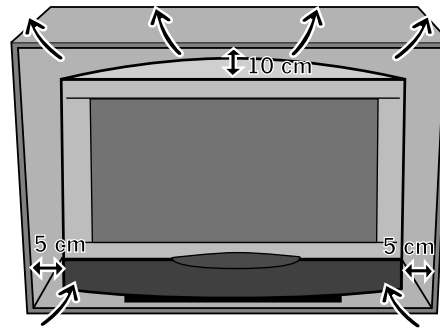

If the TV set is placed in a cabinet or on a shelf, at least 5 cm clearance at the sides and at least 10 cm at the top must be left to allow air to circulate. Stand the TV set in a place where it is not exposed to direct sunlight or additional heating from radiators.

- Magnetic fields influence the picture quality of the TV set. Therefore, do not place loudspeakers or other magnetic sources immediately next to the TV set.

- Avoid dropping metal objects, needles, paper clips, liquids, wax or similar into the air vents at the back of the set. This causes short circuiting of the set and could start a fire. If anything should get inside the set, switch it off immediately, pull out the plug and call the after-sales service to check it.

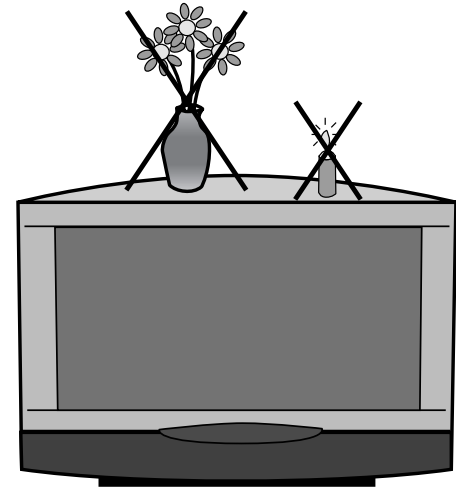

Do not place vases filled with water, lighted candles etc. on the top of the TV set.

## For your own safety

- You should never attempt to remove the rear panel of the TV yourself. The set operates with high voltages which could be fatal. Leave repairs and servicing of your TV set to authorized TV technicians.
- Due to the picture tube, TV sets have their center of gravity fairly near to the front. The TV set therefore has a tendency to tip forward relatively easily which could cause injury to persons.  
Only stand the TV set on a level, firm base. The set must stand on all feet. The TV should not overhang particularly when it is placed in a cabinet or on a shelf.  
If the TV is placed on a stand, make sure this is larger than the surface area of the base of the TV.

When using turntables and drawer shelves, make sure they have a sufficient load capacity.

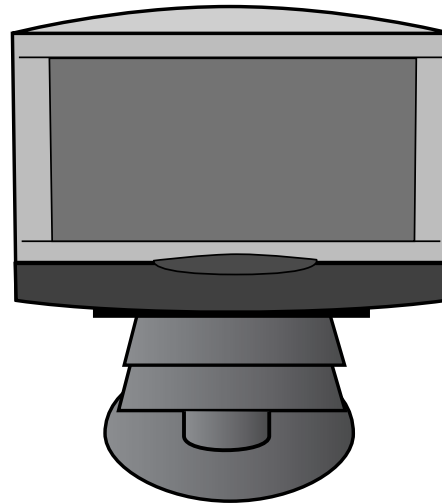

We recommend you to use only original parts, e.g. Loewe racks and stands.

If the TV set is placed on a console with castors, move the console carefully because the console and the TV could tip over. Consoles with castors may considerably reduce the stability of the sets placed on them so only use consoles specially designed and approved for the TV. Never allow children to handle the TV set unsupervised.

Do not allow children to play close to the TV set, they could knock, push or pull it from the stand and injure someone.

- Do not place the TV anywhere where it may be exposed to vibrations because this can lead to overloading of materials.
- Do not leave the TV on unsupervised.
- Pull out the antenna and mains plugs during a thunderstorm. Surge voltages from lightning strikes can damage the set both through the antenna system and the mains. You should also pull out the antenna and mains plugs during long periods of absence.
- The mains plug of the TV must be easily accessible so that it can be disconnected from the mains quickly at any time.
- Lay the power cable so that it cannot be damaged. The power cable may not be kinked or laid over sharp edges, and may not be walked over or exposed to chemicals; the latter applies for the entire TV set. A power cable with defective insulation can lead to electric shocks and is a fire risk.
- When you pull out the mains plug, do not tug the cable but hold the housing of the plug. The cables in the mains plug could be damaged and cause a short circuit the next time it is plugged in.



# Initial installation

## Batteries – Remote control

To insert or change the batteries, press the point marked by an embossed arrow. Push the cover of the battery compartment down and remove it. Insert the batteries of the alkaline manganese type LR 03 (AAA) with the correct polarity (+/-).

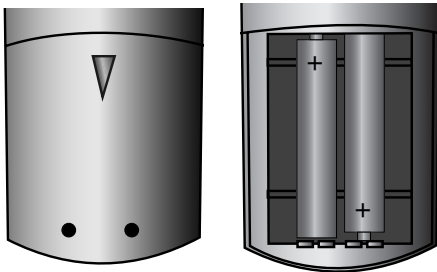

Then push the cover back on.

### Note on disposal of batteries:

The original batteries do not contain any pollutants such as cadmium, lead and mercury. Used batteries do not belong in the domestic waste. They must be taken to the appropriate collection points according to the national laws. Ask your dealer.

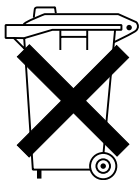

## Connection

### Mains

Connect the TV set to a 230V/50–60 Hertz outlet.

### Antennae

Connect your antenna or cable system to the antenna socket of the PIP tuner.

Plug the antenna plug protruding from above the PIP tuner into the antenna socket of the VHF/UHF tuner.

If your TV set is equipped with a DVB-T module, connect your antenna or cable systems to the top socket of the DVB-T module (IN) and connect the bottom socket (OUT) to the antenna input of the PIP tuner. If equipped with one or two satellite tuners, connect the SAT antennae to the SAT sockets (see figure on page 5).

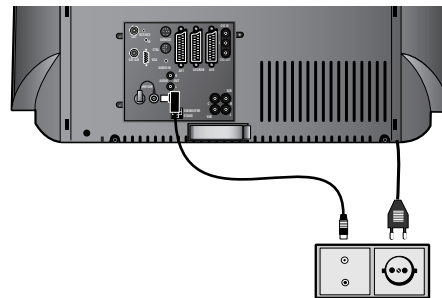

## Switching on

The On/Off switch on the TV set is located behind the control panel. Open the flap of the control panel.



Press the On/Off button so that it is pressed in.

## Initial installation

Automatic programming of the TV set is started the first time you switch it on. Follow the menus.

First you have to select the menu language for your set. Then you specify which antenna you have connected to your TV and in what country you are using it. Then you start the station search. The TV set searches for, stores and sorts all the stations which your antenna system receives. You then see a list of the stored stations in which you can mark your favorites. Finally log in your video recorders, decoders, Loewe audio system and Home Automation with the connection wizard and connect these to the TV set according to the illustrated connection plan.



Select the settings with the arrows on the ring ...



... confirm the settings with **OK**. You then move on to the next menu ...



... press this button if you want information about the settings.

You can repeat initial installation at any time, e.g. after moving house. Call the index in the main information (i button). Then select the item "Repeat initial installation". Then start "Initial installation" with **OK**.

# Daily handling

## Switching on/off

Your TV set is equipped with an eco-standby power supply unit. The power consumption drops to low power in standby mode. If you want to save even more energy, switch the set off with the On/Off switch. However, please note that EPG data are then lost and timer recordings programmed on the TV set will not be carried out.



If the TV is switched on, you can switch it off with the blue On/Off button on the remote control. The red standby LED on the set lights up. If the green LED also lights, a timer recording is in progress on the VCR or built-in digital recorder, EPG data is being acquired or radio mode without screen display is active.



From standby it is best to switch back on with the blue On/Off button or with a numeric key (station 0-9). The green operating LED then lights up.



When you switch on the TV with OK, you see the station table and can choose a station.



Switch on in the radio mode.

The On/Off switch on the TV set is located behind the control panel.



None of the indicators lights up when you switch off the TV set with the On/Off button on the set.



Switch on the TV set with the On/Off button on the set when it is switched off.

## Changing channels



Channels up/down (only favorite stations if these are shown in the station table).

### With the numeric keys on the remote control

The set has a dynamic memory with 220/with DVB 1470 memory slots. If up to 9 stations are stored, you only need to enter one number, up to 99 two numbers, up to 999 three numbers and above 999 four numbers (please look in the station table to find out how many stations have been stored).



#### 1-digit stations

Keep the button 0 – 9 pressed for one second, the channel then changes immediately.  
or press the button 0 – 9 briefly, the channel then changes after 2 seconds (immediately when up to 9 stations are stored).



7  
long



2 7  
short long



1 2 7  
short short long

#### 2-digit stations

Keep the second numeric key pressed for one second, the channel then changes immediately.  
or press both numeric keys briefly, the channel then changes after 2 seconds (immediately when up to 99 stations are stored).

#### 3-digit stations

Keep the third numeric key pressed for one second, the channel then changes immediately.  
or press the three numeric keys briefly, the channel then changes after 2 seconds (immediately when up to 999 stations are stored).

#### 4-digit stations

Press the four numeric keys briefly, the channel then changes immediately.



1 2 7 8  
all short

Depending on how many stations have been stored, you can place one or more zeros in front of the number and select for example station 7 = 07 or 007 or 0007.

## With the station table



Call the station table with OK

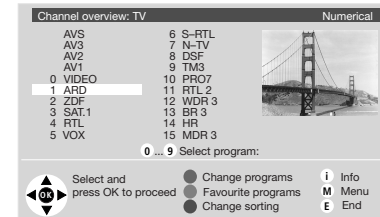

Mark the station (the marked station is shown in the PIP picture)



or  
Mark with numeric keys



Call the marked station



Sort alphabetically/numerically (blue button)



Display favorite stations only (yellow button)

## Call Audio/Video programs – AV selection



for playing AV equipment (see also page 19).



Select AV socket or VIDEO for VCR station.

# Daily handling

## General menu operation

With the TV and picture menus, we show you how to navigate within the menus. Which buttons you can use for operation is shown at the bottom of the appropriate menu.

**Call the TV menu**

**Mark (white field)**

**Call the menu with OK or**

**Grey items cannot be selected**

**Set (setting value and bar)**

**Mark other menu items**

**Select (frame)**

**Show/hide info texts**

**Back to the previous menu level**

**Hide all menus**

## Adjusting the sound

### Set the volume

**Set the volume**

other ...  
Volume 36

with "others ..." you can select and ...

Listening mode Stereo Panorama Dolby Virtual  
Loudness  
Sound adjust  
Volume

... set other sound settings.

### Mute

Sound off;  
Sound on: press button again or adjust volume

Sound off      Sound on

### Other sound settings:

**Call TV menu**

**Mark "Sound"**

**Call sound functions**

**Mark sound function**

**Set/select**

Sound settings: Sound via the loudspeakers of the TV set or another system. Sound adjust, treble, bass, loudness and balance. Sound select for loudspeakers and headphones, AV output sound. Volume of the headphones, automatic volume and max. volume.

## Adjusting the picture

### Call the Picture menu

**Call the TV menu**

**Mark "Picture"**

**Call picture functions**

### Select picture settings

**Mark picture function**

**Set/select**

Picture settings: contrast, colour, brightness, picture format, focus, colour tone, picture adjustment, noise reduction (DNC), movement compensation (DMI), automatic picture size adaptation (AMD) and rotate picture in large picture tubes.

## Operation on the TV set

### Changing channels on the TV set

**Channel up**

**Channel down**

### Volume, contrast and color

**Press the function button until the desired function is marked**

**More volume, contrast or color**

**Less volume, contrast or color**





# Modes of operation

## TV mode

In initial installation and daily operation, the TV set is in TV mode. This is also the case when none of the other modes of operation such as EPG, Teletext, PIP, Video or Radio is selected. Every one of these modes of operation has a menu which you can call with the M-button and with some color button assignments.

### Function of the color buttons in TV mode

You can assign the functions of the four color buttons yourself. The following functions are set at the factory:

-  red: list or call personal teletext pages
-  green: call picture format setting
-  yellow: call last viewed station
-  blue: call station info

You can assign other functions to the buttons in the TV menu "Settings" – "Function keys".

### Status display

 Show/hide status

Clock	20:15
1 ARD	Stereo

### Main information

 Call main information

Main information	
Autom. channel search	
Connections	
Explanation of the remote control	
Index	
Technical spec. of TV set	
Select control level	

 Select and call up with OK

 Info

 Back

 End

The **explanation of the remote control** shows the function of every button in different modes of operation of the TV set and the remote control.

The **index** answers many questions regarding all aspects of the TV. If it is a question about the operation, you have direct access to the operating function from the index.

Loewe TV sets are supplied in different models with different equipment. You can find out what equipment your TV has under the menu item "**Technical spec. of the TV set**".

When you have made all the settings and connections, you can switch over to "Simplified control" using "Select Mode". Then the "Settings" and "Connections" can no longer be launched in all modes of operation menus. Switch "Simplified control" back off when you want to make settings.

### Call the TV menu

 Launch the TV menu

TV menu
Standard settings
Picture
Sound
zap2text
Connections
Settings

### zap2text

Some stations use this service. If teletext pages are referred to during a program, the TV set saves and/or displays this page number. You call the teletext page with the T button from the display during the program or from this menu.

### Standard values

You can save the setting for picture and sound you have made in this menu and launch them again later.

### Connections

You will find information about this in the chapter "Logging in and connecting AV equipment" on page 18.

Some **settings** in the TV menu:

### Child lock

Use the child lock if you want to prevent your children watching after a certain time, once or daily, all or certain programs.

### On-screen displays

You can define duration and position of the displays, the content of the program and status display and activate or deactivate zap2text as a display.

### Timer functions

You can have your TV switch on and off at specific times or have yourself reminded by a signal tone.

### Time and date

When you receive teletext, the TV records the right date and time settings. The time serves as information for timer recordings, timer functions and EPG. If you do not receive teletext you should set the date and time and not switch the TV off with the mains button as the settings will then be lost.

### Language

If "your" menu language is not set, you have to select the "Language" menu in a language you cannot understand:

Press the **M**-button (TV menu), mark the last menu item (settings), press the **OK** button and mark the last menu item (Language) under "other ..." and press the **OK** button.

Now select the right language and confirm with **OK**.

# Modes of operation

## Picture in Picture (PIP)

### Standard PIP functions:

In standard PIP, a PIP picture is displayed in the current TV picture. The frame round the PIP picture is initially green in standard PIP.



Show/hide PIP picture

### PIP picture as still frame



The frame around the PIP picture must be green. If it is not, press the green button.



Press the red button to freeze the PIP picture.



Press again – moving picture.

### Changing the station of the PIP picture



The frame around the PIP picture must be green. If not, press the green button.



Then select the station as normal.

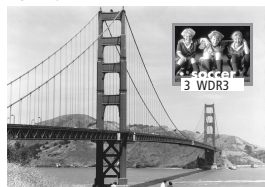

### Changing the station of the TV picture



The frame around the PIP picture must be white. If it is not, press the green button.



Then select the station as normal.



### Station scan



The frame around the PIP picture must be green. If it is not, press the green button.



Start the station scan with the blue button. The PIP frame turns blue.



The programs now change automatically. Stop the program scan with the blue button. The PIP frame turns green again.

### Changing PIP picture/TV picture



The frame around the PIP picture must be green. If it is not, press the green button.



Change the pictures with the yellow button.



### Position of the PIP picture



Call the PIP menu with the M-button.



Select "Position"



Select the symbols for the position



Hide the PIP menu

### Resolution of the PIP picture



In the PIP menu, select "Resolution"



Set to "large" or "small"

### Split screen (for 16:9 screen only)



In the PIP menu, select "Type"



Select the symbol for Split Screen.



Hide the PIP menu

The picture on the right is the PIP picture and has no sound. The vertical line represents the colour of the frame around the PIP picture.

### Setting "iPIP"

Switch on PIP, call the PIP menu with the M button.

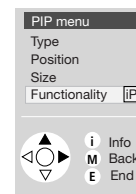

Mark "Functionality"



Select "iPIP"



Hide menu

### iPIP function:

In iPIP the TV picture currently displayed becomes the PIP picture. Select another program for the TV picture and keep your eye on the PIP picture. In this way you can temporarily "ban" commercials or parts of programs to the PIP picture. In iPIP, the frame round the PIP picture is orange.



PIP picture on/off

The PIP picture becomes a TV picture again when you switch off PIP.

# Modes of operation

## EPG mode

EPG is the electronic program guide for TV programs. With this system, you can easily find the stations that interest you (sorted according to time, day, topics and programs). You can memorize stations and station recordings.

A wizard is activated the first time you use EPG (not with DVB) which guides you through the necessary settings. Then run the data acquisition (see page 15).

### Using the EPG



#### Switch EPG on/off

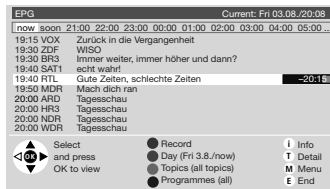

The first line is framed initially in green. The **green frame** stands for **time and date**, with the green button you switch between time and day or, if the frame has a different color, back to the green frame. With the arrow buttons  $\leftarrow \rightarrow$  you select: now, later, the time or day for starting stations. The list of stations below is updated accordingly. With the buttons  $\nabla \triangle$  you mark a station you want to watch (now running), memorize or record.



The frame turns yellow when you press the yellow button. The **yellow frame** means you can **select topics**. With the arrow buttons  $\leftarrow \rightarrow$  you choose between personal topics, all topics and the individual main topics such as Film, News, Show, Music etc. The list of stations below is updated accordingly. With the  $\nabla \triangle$  buttons, you

mark a station you want to watch (currently running), memorize or record.

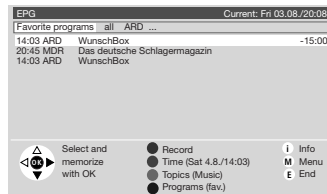

The frame turns blue when you press the blue button. The **blue frame** signifies **station selection**. Use the arrow buttons  $\leftarrow \rightarrow$  to choose between your favourite stations, all stations or the station just set. You can select another individual station by moving to "..." with  $\rightarrow$ , marking a station in the list and storing it with **OK**.

The respective current settings are shown next to the operating notes for the color buttons.

### Direct input of time

You can also enter the time directly with the numeric keys of the keypad. After entering the first digit, the time is displayed first next to the symbol of the green button by asterisks and is then replaced by the entered numbers, e.g. 2100. If the entered time has already passed, its entry is used for the following day.

### Watch or memorize a station

You memorize the station marked with the  $\nabla \triangle$  buttons by pressing the **OK**-button. A + sign is set in front of the program title for noting. At the start of the broadcast, this program is switched for or you see a message.

### Programming a VCR or Digital Recorder (DR) recording

You prepare the program marked with the  $\nabla \triangle$  buttons for recording by pressing the red button. For "Timer recording" select DR (Digital Recorder") or VCR and whether a single recording is to be made or a serial is to be recorded. A red dot is displayed in front of the program title.

If a program is already marked by a red dot, you can delete the timer data again (the red dot disappears).

### Calling detailed information

If detailed information about the selected station is available, you will see the **T**-button displayed additionally. You can call the detailed information with this button.

Other **functions** in the EPG menu:

#### List of memorized stations

You will find the stations you have memorized in a list, also DVB radio stations.

#### Switch on TV at memo

You can have the TV switched on automatically from standby at the time of the memorized station. If you are not in at the time, a safety prompt makes sure the TV switches off again after 5 minutes.

#### Indicate/start memorized station

If the TV is already on when the memorized station starts you can have the start of the station indicated or the TV switched over immediately.

#### Short info lines

Short infos are broadcast for many programs. Set how many lines this information should have or switch the short info lines off.

#### EPG entry

If you want to start EPG operation, you can retain your last settings for topic and program selection or start with all topics and all programs.

# Modes of operation

## EPG settings

If you want to change the provider or want to have other programs evaluated, you can do this in the EPG menu.

### Provider search



EPG on/off



Call EPG menu

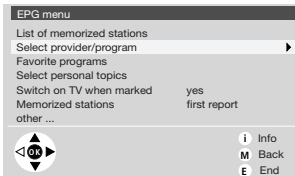

Mark "Provider/Select station"



Call

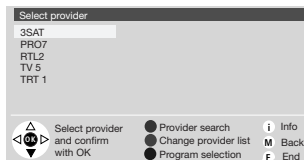

Start provider search (green button). This may take some time.



Mark the provider



Save the provider

This is followed by a station search and a list of TV stations is displayed which transmit data. Move on to the provider selection with the **OK**-button. If the stations offered are what you want, move on to the station selection with the blue button.

## Selecting stations for EPG

Select the stations here for which information is to be collected.

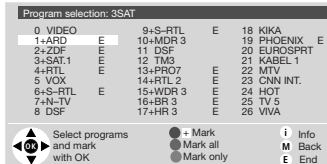

Stations marked by + are favorite stations. The provider supplies information for stations marked by E (terrestrial, cable and analog satellites) and D (digital), these are already marked (blue letters).



Mark the station/Remove the marking



red: Only mark favorite stations



green: Mark all stations



yellow: Only mark this station



Back to the EPG menu



## Switching data acquisition on/off



Mark "Data acquisition" in the EPG menu under "other"



Select data acquisition off/on

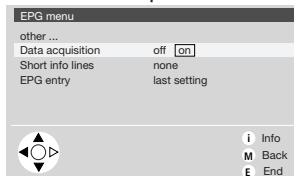

If, for example, you cannot receive any EPG providers and no DVB is installed in the TV set, you should switch off the data acquisition.

## Performing data acquisition

The data must be collected first after these settings or every time the TV is switched off. To do this, select the program which you have defined as a provider and leave it switched on for about one hour or switch the TV set to standby mode. The green LED lights up in addition to the red LED after about two minutes. Data acquisition takes about one hour, in sets with a DVB module a little longer. The data are automatically collected between 2 and 5 in the morning when the TV is switched off to standby.

## Defining personal topics

You will find the programs that interest you faster when you define your personal topics. Mark "Select personal topics" in the EPG menu and put together your list of personal topics.

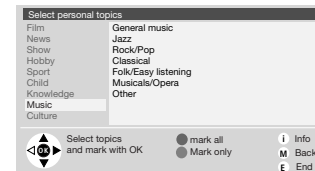

## Radio mode

You can switch the radio mode on and off with the button. If at least one satellite tuner and possibly a DVB module are installed in your TV set, you will be able to receive radio stations. If none of these additional modules is installed, you can only select the audio inputs and play back through these with the station table or the buttons.

# Modes of operation

## Teletext mode

Teletext transmits information such as News, Weather, Sport, Program Previews and Subtitles.

**T** Teletext on/off



Many stations use the TOP operating system, some use FLOF. Your TV supports both these systems. The pages are divided into general topics and topics. After switching on the teletext, up to 3500 pages are stored for fast access.

### Selecting pages with the colored buttons

The colored bars (in TOP) or the colored writing (in FLOF) show you which colored buttons to use to scroll to general topics and topics.

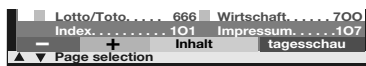

- red: back to previously viewed page (not with FLOF)
- green: forward to next page (not with FLOF)
- yellow: to the next topic (only in TOP and FLOF)
- blue: to the next topic (only in TOP and FLOF)

## More functions for page selection

Mark a specified page number on the page (Page Catching)



Launch

Scrolling in stored sub-pages. In the bottom line you will see which sub-pages you can already launch.

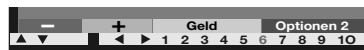

Launch contents page 100



The TOP table is a general list of teletext. You can only launch the table on channels which use the TOP operating system.

- Launch the TOP table
- Mark a general topic
- Select the Topics column
- Mark menu items
- Display page

Enter the page number directly

## Displaying teletext pages

Stop self-turning pages (HOLD)

zoom: top half– bottom half – normal size

TV picture on/off (Split text)

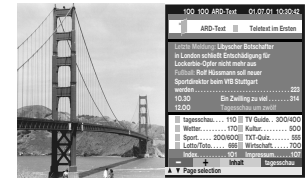

## Teletext menu

Launch teletext menu

- Menu
  - News flash
  - Show
  - Station +/-
  - Sub-page
  - Recording
  - Timer
  - TOP table
  - Settings
- Info  
 M Bck  
 E End
- Here you will find functions such as "New message", "Reveal" hidden information, switch to other, enter 4-digit sub-page number directly, programme video timer recordings via teletext and launch the Timer overview.
- In the settings you will find menus to define the preview pages, subtitle pages and personal teletext pages.

## Set volume

You can adjust the volume in teletext mode after pressing the sound off/on button .



# Modes of operation

## Video mode

You can operate Loewe video recorders and DVD players with the video control bars even if they are hidden. The VCR's must be connected to the Euro AV sockets (Scart) and logged in under the "Connections" menu.

Digital Link must be switched on on the Loewe video recorder. Only then can you use the control bar. You also need Digital Link or Digital Link Plus for timer recordings of satellite programs controlled by the TV set.

You can display up to three control bars but they are only displayed by logged in VCR's and DVD players.



Show/hide video control bar

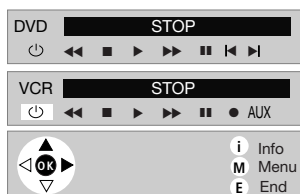

Select the video control bar if several VCR's or a DVD player and a VCR are connected.



Select function



Switch VCR/DVD on/off



Select video input (Euro-AV socket) for the VCR



Rewind (only for VCR) or Scan in rewind



Stop (STOP)



Playback (PLAY)



Fast forward (only for VCR) or Scan in fast forward



Pause (PAUSE)



Next chapter (only for DVD)



Previous chapter (only for DVD)



Record



Perform selected function.

When you start a recording, the program you have just selected is recorded. You cannot switch over to another channel, it is locked. You can only switch over when the recording has finished.

Exceptions:

1. You have installed several tuners (not PIP tuners) in the TV set, then you can watch another channel with the second tuner.
2. You can also watch the signal via an AV connection (e.g. DVD player or a second VCR).
3. In a VCR with Digital Link Plus the VCR tuner is used for the recording (not for satellite programs).

### Video menu



Show the Video menu

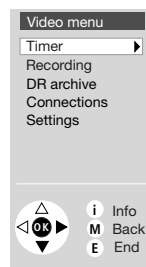

The Video menu provides you with the following options:

You can change and delete timer data or program new recordings in the "Timer" menu.

The "Record" menu gives you the option for timer programming by EPG, teletext or manually. You can call the archive list with "DR Archive" if a Digital Recorder is built in.

In the "Connections" menu you can log other AV equipment on or off. In the "Digital Link Plus transfer" menu the station data of the TV set (not satellite stations) are transmitted to the Digital Link Plus VCR.

In the Settings menu you can enter the record lead and follow on time and serial recording tolerance.

**Digital Link Plus** VCRs have the possibility for transferring the station data from the TV set to the VCR via the Euro-AV cable (not for satellite stations). Every time you change the station memory of the TV, you are asked whether you want to make a data transfer.

The receiver unit of the VCR is always used for recording with a Digital Link Plus video recorder (not satellite stations) and the tuner of the TV set is available for watching TV.

Loewe VCRs also have **Digital Link**, a system for controlling Loewe VCRs via the Euro-AV cable. If the Loewe VCR only has Digital Link, the TV tuner is used for recording. If you have installed your Loewe VCR in a concealed place, you can operate the Loewe VCR with the remote control. Operation with the control bar also works with Digital Link.

**Digital Link must be switched on on the video recorder.**

Only use fully wired Euro-AV cables, otherwise Digital Link or Digital Link Plus will not work.

# Operating additional equipment

## Logging in equipment

You have already logged in and connected all connected devices (video recorders, camcorders, DVD player, DVD recorder, Loewe audio system, Pay-TV decoders, Loewe home automation, door intercom) with the connection wizard when you put it into operation for the first time. If you want to connect further or different devices, you have to call the connection wizard in the TV menu – "Connections".

## Connecting VCR equipment

In addition to the connection via the Euro-AV socket, you also have to connect the antenna (only for antenna or cable systems) through the VCR to the TV set. The antenna signal is then available both to the tuner in the VCR and the TV tuner. If a DVB-T module is installed, connect the VCR to the IN socket of this module.

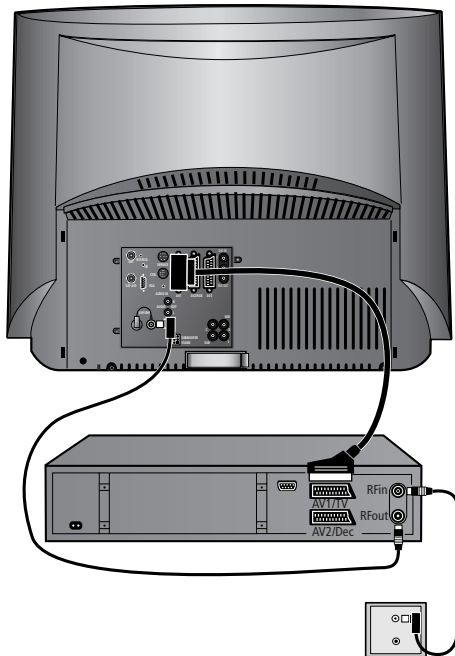

## Search for and store the VCR station (if there is no Euro AV cable)

Switch on the test station on the VCR or insert a recorded tape and start playback.

Then call program 0 on the TV set (set ex-factory to channel 36). Select the first menu item (VCR) in the AV selection list.

To prevent "normal" TV stations being found in the search, pull out the antenna plug from the antenna input of the VCR temporarily (the plug attached to the cable to the antenna system).

Search for channel (blue button)

When the station is found:

Store (red button)

A list of the stored stations is displayed

Overwrite program (program 0 marked)

Hide menus

Plug the antenna plug back into the VCR. If you now get interference because a TV station is transmitting on the same channel as the VCR station, you have to change the transmitting station on the VCR (see operating instructions of the VCR) and search for the VCR station on the TV again.

# Operating additional equipment

## Video playback

There are several ways to see the picture and hear the sound of the VCR, DVD player or camcorder on your TV:

1. Use the Euro-AV sockets on the TV and VCR.  
This is the best way to get a good picture and sound quality. For camcorders it is best to use the front sockets AVS.  
If you are playing back from a VCR with Digital Link Plus, the VCR picture is shown on the current station slot.  
If you are playing back from a standard VCR, DVD player or camcorder, select the AV socket to which the video signal is connected in the AV selection list or the station table.  
Video recorders emit a switching voltage during playback which the TV set can decode (can be activated for every VCR in the connection wizard or set Settings – AV Settings – Allow switching voltage to “Yes” in the TV menu). Then the VCR picture is shown on the current station slot as in Digital Link Plus VCR's.
2. You can also control logged-in Loewe VCRs and DVD players with the video menu bar. See page 17 for more details.
3. Use the antenna connection between the VCR and the TV. The sound is only transmitted in mono. Select the first menu item, e.g. VIDEO, in the AV selection.

## Calling an AV program in the AV selection list



Call AV selection list

AV Selection VIDEO AV1 AV2 AV3 AVS



Select AV socket or VIDEO for VCR transmitter.

Now you will see the playback from the connected AV unit.

## Calling an AV in the station table



Call the station table

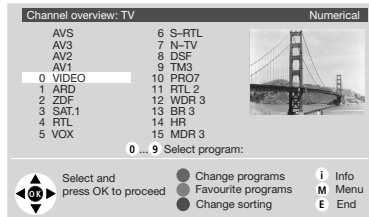

In the numeric sorting you will always find the AV sockets at the top of the list without station numbers.



Mark the AV socket



Call the marked AV socket

Now you will see the playback from the connected AV unit.

# Operating additional equipment

## Operating Loewe video recorders and Loewe DVD players directly

You can switch over the remote control of the TV set to operate Loewe video recorders and Loewe DVD players. These devices can be operated directly or, in the case of equipment installed in a concealed place, by the TV set. In this case the Digital Link function of the VCR must be switched on.

### Select the device to be operated:



for VCR:  
the VTR indicator on the remote control lights up ...



press again, the DVD indicator lights up ...



press again, none of the indicators lights, the TV is then activated.

The TV cannot be operated if VTR or DVD is switched on. In this case switch back to TV or wait 20 seconds until the remote control automatically switches back to TV mode (none of the indicators lights).

Loewe VCRs VV3600H, VV8500H and VV5000M cannot be controlled with this remote control. Please use the original remote control or the video bar.

## Functions for Loewe video recorders

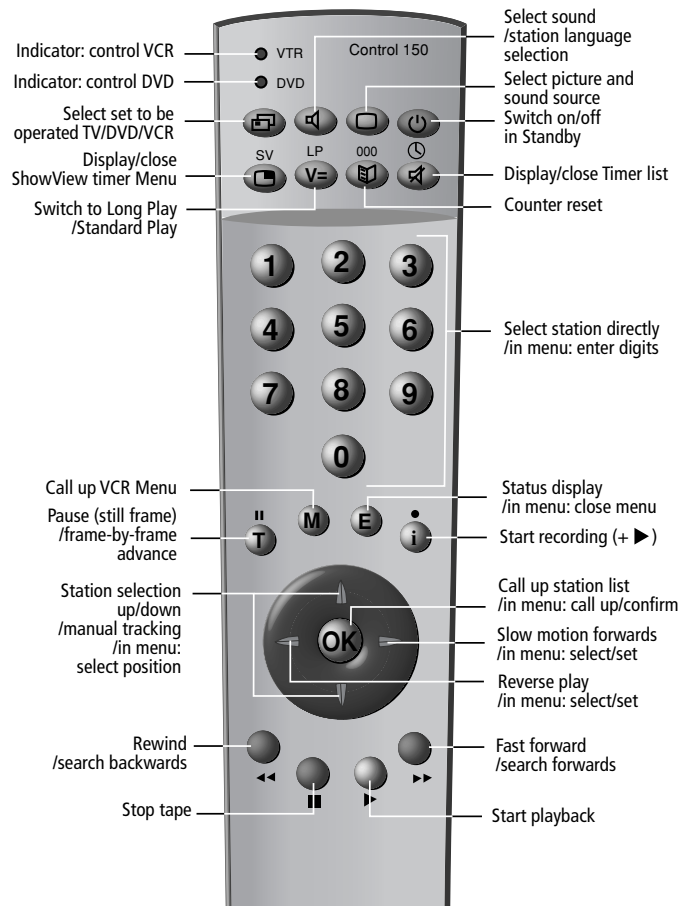

## Functions for Loewe DVD players

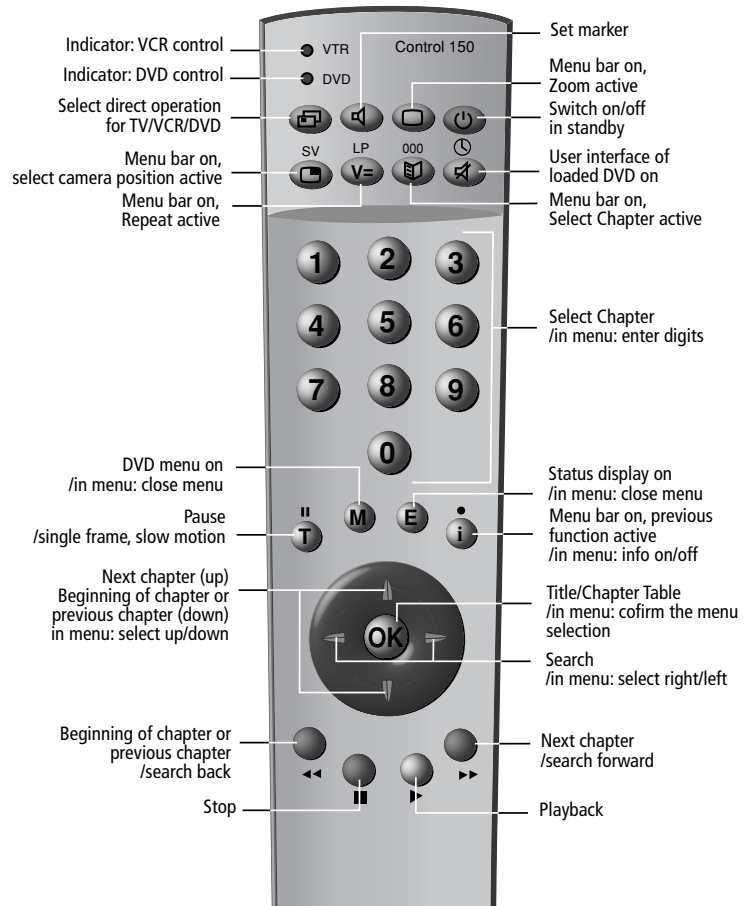

## What to do when ...

Problem	Possible cause	Remedy
Various menu items cannot be called (shown in gray) or the menus for the EPG and teletext modes of operation cannot be called	"Simplified control" activated in main information	Deactivate "Simplified control" in the main information. Press the i-button, select "Select control level" and call with <b>OK</b> . Set the "Simplified control" to "no".
Timer recording, Change timer and Clear timer are not shown in the Video menu	No video recorder logged in	Log in VCR in the TV menu – Connections.
"Connections" cannot be called in the Video menu (shown in gray)	a) A timer recording is currently in progress b) You are recording from the TV set with the video bar	a) Wait until the timer recording has ended or clear the timer. b) Wait until you stop recording.
The "Stations" item in the TV menu and the "Automatic station search" item in the main information cannot be called	The child lock is activated. If these menus were accessible, children could still set the programs.	Deactivate program-related child lock: Switch off child lock or enter PIN in the TV menu - Settings.
Control of the Loewe VCR with the video control bar and the timer does not work or does not work properly	a) The VCR's Digital Link function is not activated or not possible b) Euro-AV cable not connected c) Video recorder not logged in	a) Activate Digital Link in the VCR (see operating instructions of the VCR) b) Connect the Euro-AV cable c) Log in the VCR
General problems with connecting external devices through an AV input	a) The device is not logged in in the "Connections" menu or is connected differently to shown in the connection diagram b) The AV norm is set incorrectly c) The AV signal is set incorrectly	a) Compare the connection diagram with the actual installation in the "Main information" under "Connections" and connect as shown if necessary. b) Set the correct norm. c) Set the correct AV signal. If "Automatic" is set for AV norm or AV signal, this can lead to wrong detection in the case of non-standardized signals. In this case the norm and signal must be set according to the operating instructions of the external device.
Picture shifted horizontally	The TV set is in the Southern hemisphere (e.g. Australia, South Africa)	Set the horizontal position: 1. Call the main information with i 2. Call Index – Set picture – Horizontal displacement 3. Set horizontal picture position.

## What to do when ...

Problem	Possible cause	Remedy
Connection of a decoder does not work or does not work properly	<ul style="list-style-type: none"> <li>a) The signal is not decoded because the correct decoder programs have not been selected in the TV menu - Connections</li> <li>b) The sound is missing in decoder mode because the wrong decoder sound is allocated in the TV menu - Connections</li> </ul>	<ul style="list-style-type: none"> <li>a) Follow the instructions in the TV menu – Connections again and select the appropriate decoder programs.</li> <li>b) Follow the instructions in the TV menu – Connections again and select the right sound source (decoder, TV or Autom.), see instructions of the decoder.</li> </ul>
No sound through the TV loudspeakers	<ul style="list-style-type: none"> <li>a) The item "Sound from..." in the Sound menu under "Sound" is not set to "TV"</li> <li>b) Nothing is inserted in the 9-pole cube socket on the back of the set</li> </ul>	<ul style="list-style-type: none"> <li>a) Change the setting to "TV".</li> <li>b) Either a dummy plug with bridges, Loewe Concertos, the transmitter for the home automation or a subwoofer must be plugged into the cubic socket.</li> </ul>
All menus appear in the wrong language	The wrong menu language has been set	Set your menu language: <ol style="list-style-type: none"> <li>1. Switch off picture-in-picture (PIP) and switch off all on-screen displays, press the <b>E</b> button</li> <li>2. Call the TV menu (press the <b>M</b> button)</li> <li>3. Select the last menu item and press <b>OK</b></li> <li>4. Select the last menu item on the last page and press the <b>OK</b> button</li> <li>5. Now select the right language and....</li> <li>6. ... confirm with <b>OK</b>.</li> </ol>
Digital Link Plus does not work	<ul style="list-style-type: none"> <li>a) The VCR has not been logged in as a Digital Link Plus device or has been connected to the wrong socket</li> <li>b) The Euro-AV cable is not fully wired (Pin 10 not wired)</li> <li>c) Some video recorders can only take over the stations from the TV in initial installation</li> <li>d) All or some terrestrial or cable stations are stored at station slots <math>\geq 99</math></li> </ul>	<ul style="list-style-type: none"> <li>a) Log in the Digital Link Plus VCR under "Connections" and connect according to the diagram.</li> <li>b) Change the Euro-AV cable</li> <li>c) Reinstall the original state (ex-factory) of the VCR (see operating instructions of the VCR)</li> <li>d) Sort the terrestrial and cable stations so that they are between 1 and 99.</li> </ul>
Various characters are displayed incorrectly in teletext	The wrong character set is set in the teletext menu	Set the right character set: Teletext menu – Settings – Character set – Standard or the appropriate character set.

# Technical data

## Mechanical data

Aconda 9272	Part number 63460
Aconda 9372)	Part number 63461
Dimensions (cm)	80,5x59x54,5 (wxhxd)
Weight (kg)	44
Picture tubes	Real Flat-Line
Format	4:3
Screen size	72 cm, visible 68 cm
Aconda 9281 HD	Part number 63462
Aconda 9381 HD	Part number 63463
Dimensions (cm)	85,5x62,5x57,5 (wxhxd)
Weight (kg)	55
Picture tubes	Real Flat-Line HD
Format	16:9
Screen size	81 cm, visible 76 cm

## Electrical data

Chassis name	Media Plus (Q2550/H)
Image refresh frequency	PAL/Secam 100 Hz
	PAL 60/NTSC 60 Hz proscan
Full Digital 100	AMD*/DMI/DMM/DNC
Power supply	220V up to 240V/50–60Hz
Power consumption	in operation approx.145 Watt
	Standby <2.5 Watt
	Sat-Record-Mode <60 Watt
Ambient temperature	5° – 40° Celsius
Tuner VHF/UHF/ cable	
(Hyperband 8 MHz)	42 MHz – 860 MHz
Station memory*	220/with DVB:1470
TV norms	B/G, I, DK, L, L', M, N
Color norms	PAL, SECAM, NTSC, NTSC 4.,43
Sound norm*	FM, AM, Nicam
	mono/stereo/2-sound
Audio rated output	2 x 15 Watt / 4 Ohm
Audio music output	2 x 40 Watt / 4 Ohm
Teletext	HiText (Level 2.5)

## Connections

Mini-DIN (Front)	Video IN	Y/C (S-VHS/Hi8)
Cinch (Front)	Video IN	CVBS (VHS/8mm)
Cinch (Front)	Audio IN	L+R
Jack 6.3mm (Front)	headphones	32–200 Ohm
IEC sockets	75 Ohm	antenna/cable/DVB-T*
F-sockets	75 Ohm*	SAT and SAT A/D
AV 1	Video IN/OUT	Y/C (S-VHS/Hi8)
	Video IN/OUT	CVBS (VHS/8mm)
	Audio IN/OUT	L+R
AV 2	Video IN/OUT**	Y/C (S-VHS/Hi8)
	Video IN/OUT	CVBS (VHS/8mm)
	Video IN	RGB
	Audio IN/OUT	L+R
AV 3	Video IN	Y/C (S-VHS/Hi8)
	Video IN/OUT***	CVBS (VHS/8mm)
	Video IN	RGB or YUV
	Audio IN/OUT***	L+R
Cinch	Audio OUT	level adjustable/fixd
Jack 3,5mm	Audio IN	L+R
Jack 3,5mm*		IR-Link OUT
Jack 2,5 mm*		RC5/RC6 OUT
D-Sub 15-pole*		VGA IN
9-pole cube socket		active loudspeaker systems
Mini-DIN 9 pole		Turning foot
Mini-DIN 8-pole		Service or Loewe audio systems (L-Link)
Cinch*	Centre OUT	Centre Signal
Cinch*	Subwoofer OUT	LFE Signal
Cinch*	Surround OUT	L+R
Cinch*	Dig. Audio IN 1	Multichannel Signal
Cinch*	Dig. Audio IN 2	Multichannel Signal
Cinch*	Dig. Audio OUT	Multichannel Signal

\* depending on equipment and type of set or retrofittable

\*\* OUT only in Digital Link Plus video recorders

\*\*\* OUT monitoring picture and sound

# Accessories available

## Racks

Ask your dealer, he will be able to offer you the right rack from the Loewe range to suit your TV set.

## Loewe audio systems and active loudspeaker systems

A combination of a Loewe TV set, a Loewe audio system and a Loewe loudspeaker system provides an excellently adapted Home Cinema system with the advantages of high operating comfort, matching design and adapted technology.

## Digital Recorder Plus

Hard disk installed in the TV set for recording and playing TV broadcasts. Depending on the selected recording quality, up to 100 hours recording capacity is available.

You can program the timer to make recordings on the hard disk and copy then to a VCR or DVD recorder later.

You can record while a program is on. Then you can retrack the programs up to 2 hours and watch something you might have missed or watch the program again. The current program continues recording in the meantime.

You can change a current program into an archive recording.

Operation with the remote control RC2/RC3 (included with the Digital Recorder Plus upgrade kit).

Can only be installed if no online module is installed.

## Wireless Home Automation

Wireless controlling of electrical installation components, such as light, canopies and shutters via the remote control.

## RC1 Remote control

Bi-directional system remote control to operate all Loewe products, such as TVs, VCRs, DVDs and audio systems. You can also operate the wireless electrical installation components.

## Single-/Twin-Sat-Tuner und Digital-TV Decoder (satellite or terrestrial)

Your TV set can be retrofitted with the integrated SAT-6 or TWIN-SAT 6 and a digital TV decoder.

Connecting both components allows reception of analog and digital satellite programs. With the Digital-TV upgrade kit 1 Sat/Twin-Sat all uncoded digital programs can be received. The Digital-TV upgrade kit 2 Sat/Twin-Sat-CI P suitable for Premiere is also available and the Digital-TV upgrade kit 2 T-CI for terrestrial digital TV programs.

## Dolby Digital Decoder

for multichannel playback from DVD players in Dolby Digital cinema quality. A Dolby Digital is integrated.

## Online module

for convenient internet and email access. Everything can be accessed via the remote control or the optional infrared keyboard.

Can only be installed if no Digital Recorder is installed.

## VGA connection upgrade for a PC

This transforms your TV set into a VGA monitor (not possible when used in conjunction with the online module).

## IR-Link

This enables you to operate a concealed video recorder from another manufacturer or the D-box, via the television using the original remote control.

## Loewe Video Recorders

Loewe video recorders are specially adapted in design, user guidance and technical characteristics to Loewe TV sets with the result that daily handling of the equipment is made much simpler.

## Loewe DVD-Players

The DVD-Players from Loewe are characterised by form and colour which match Loewe TV sets, adapted user guidance and technology. A combination of the two devices forms a system which offers many advantages.



# Service addresses

## Australia

International Dynamics Australasia Pty Ltd.  
129 Palmer Street  
AUS - Richmond, Victoria 3121  
Tel. 03-94 29 08 22  
Fax 03-94 29 08 33

## Austria

Loewe Austria GmbH  
Parkring 10  
A-1010 Wien  
Tel 01-51 63 33 034  
Fax 01-51 63 33 032

## Benelux

Loewe Opta Benelux NV/SA  
Uilenbaan 84  
B-2160 Antwerpen  
Tel. 0902-88 00 2  
Tel. 03-270 99 30  
Fax 03-271 01 08  
Loewe Opta Nederland B.V.  
Ravenswade, 54A1  
NL-3439 LD Nieuwegein (Utrecht)  
Tel. 0900-20 20 180  
Fax 030-280 33 27

## CIS

Service Center Loewe  
ul. Verkhnyaya Maslovka, d. 29  
RUS-125083 Moscow  
Tel. 095-212 50 43, 956 67 64  
Fax 095-212 47 10

## Cyprus

L&M Euroappliances Ltd  
P.O. Box 23426  
Kennedy Avenue 1A&B  
CY-Nicosia  
Tel. 02-42 05 10  
Fax 02-42 87 70

## Czech Republic

TIPA sdružení  
Dolní nám. 9  
CZ-746 01 Opava 1  
Tel: 0553-62 49 44  
Fax: 0553-62 31 47

## Denmark

Kjaerulff 1 Development A/S  
Vestre Stationsvej 9  
DK-5000 Odense C  
Danmark  
Tel. 0661-354 80  
Fax 0661-354 10

## France

Loewe France S.A.  
11 rue de la Durance  
F-67100 Strasbourg Cédex 1  
Tel. 03-88 79 72 50  
Fax 03-88 79 72 59

## Germany

Loewe Opta GmbH  
Kundendienst Zentrale  
Industriestraße 11  
D-96317 Kronach  
Tel. 09261-990  
Fax 09261-95411

## Great Britain

LinnSight Ltd.  
PO Box 8465  
Prestwick  
UK - KA 7 2YF  
Tel. 01292-47 15 52  
Fax 01292-47 15 54

## Greece

SOUND HELLAS S.A.  
Kleanthous Str. 10  
GR-54642 Thessaloniki  
Tel. 2310-856 100  
Fax 2310-856 300

## Hungary

Basys Magyarorszagi KFT  
Epitok utja 2-4  
H-2040 Budaörs  
Tel. 023-415 637/121  
Fax 023-415 182

## Israel

RIF TRADING LTD  
29 Izhak Sade Street  
ISR-Tel Aviv 67213  
Tel. 03-62 40 555  
Fax 03-62 40 303

## Italy

Loewe Italiana srl  
Lago del Perlar, 12  
I-37135 Verona  
Tel. 045-82 51 611  
Fax 055-82 51 622

## Malta

Mirage Holdings Ltd  
Flamingo Complex  
Cannon Road  
M-Qormi  
Tel. 22 79 40 00  
Fax 21 44 59 83

## Marocco

SOMARA S.A.  
377, Rue Mustapha El Maani  
MA-20000 Casablanca  
Tel. 02-22 20 308  
Fax 02-22 60 006

## Norway

CableCom AS  
Østre Kullerød 5  
N-3214 Sandefjord  
Tel. 033-48 33 48  
Fax 033-44 60 44

## Poland

Piotech  
ul. Boh. Getta Warszawskiego 18  
PL-81-609 Gdynia  
Tel./Fax 058-62 43 467 / 058-62 45 009

## Portugal

Videoacustica  
Comercio e Representacoes de  
Equipamentos Electronicos S.A.  
Estrada Circunvalacao  
Quinta do Paizinho, Arm. 5  
P-2795-632 Carnaxide  
Tel. 21-42 41 770  
Fax 21-41 88 093

## Slovenia

Jadran Trgovsko Podjetje  
Partizanska cesta 69  
SL-6210 Sezana  
Tel. 057-310 441  
Fax 057-310 442

## South Africa

THE SOUNDLAB PTY LTD  
P.O. Box 31952  
Kylami 1684  
Republic of South Africa  
Tel. 011-46 64 700  
Fax 011-46 64 285

## Spain

Gaplasa S.A.  
Conde de Torroja, 25  
E-28022 Madrid  
Tel. 91-748 29 60  
Fax 91-329 06 71

## Sweden

Canseda AB  
Amalia Jönssons Gata 19  
S-421 31 Västra Frölunda  
Tel. 031-70 93 760  
Fax 031-47 65 15

## Switzerland

Telion AG  
Rütistrasse 26  
CH-8952 Schlieren  
Tel. 01-732 15 11  
Fax 01-730 15 02

## Turkey

Enkay Elektronik Servis Müdürlüğü  
Alemdag Cad. Site Yolu No.: 10  
Ümraniye/ Istanbul  
Tel. 0216-523 15 94/96  
Fax 0216-523 16 58

Printed in Germany  
3/05.04/1,0  
Subject to modification.

 The code number 3001 cancels out a secret code and with it the child lock.  
Please keep it in a safe place.